

Stalk Control Functions:

Volume up
Volume Down
Seek Up
Seek Down
Source

Available CAN Messages:

Steering Control
Speed Pulse
Reverse
Illumination
Ignition

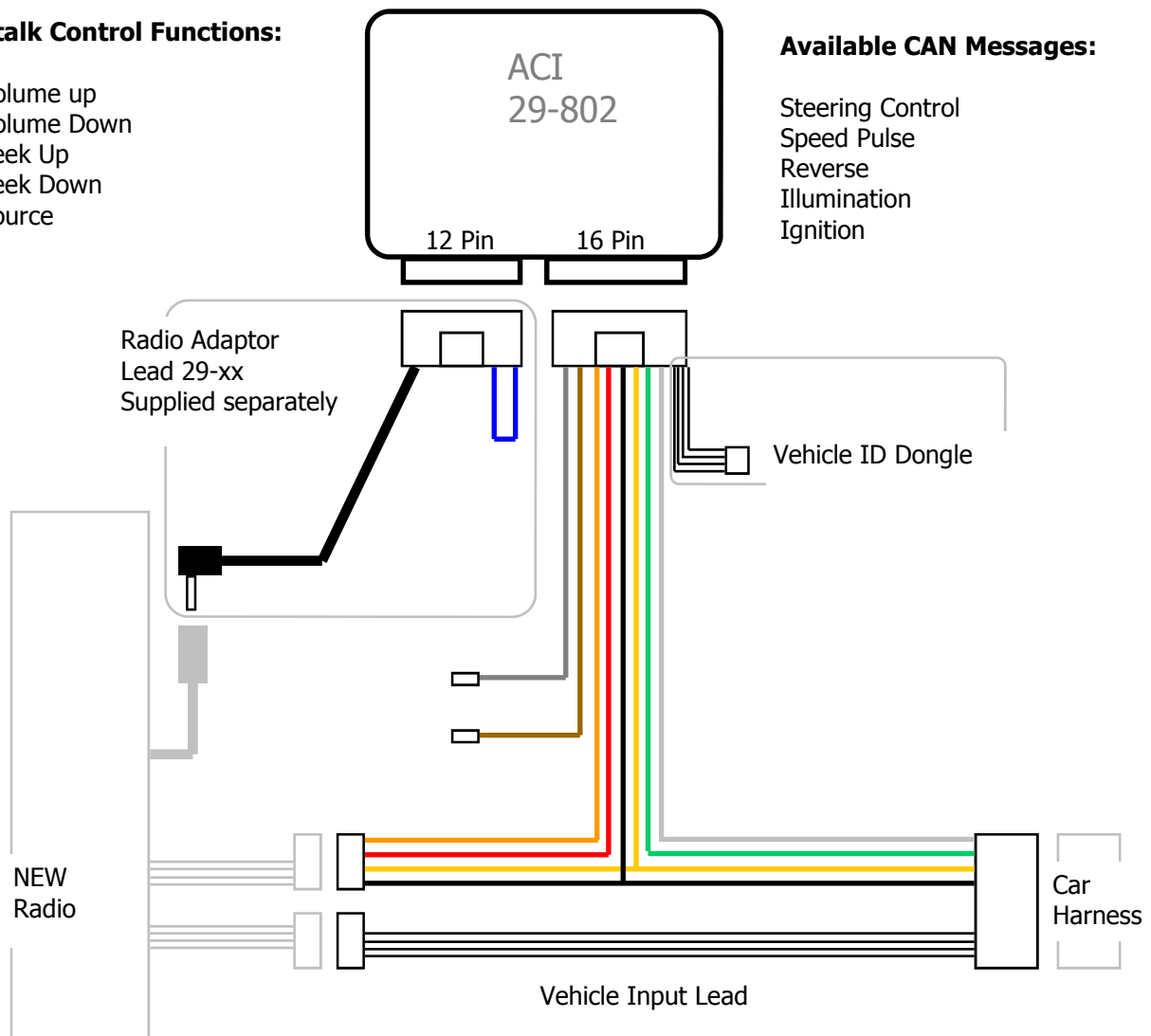

1. Connect the 12 pin Head-unit adapter (see overleaf for models) to the main ACI Black box. **It is very important that this lead is connected before any power is supplied to the unit.**
2. Make sure that the 16 pin connector is plugged in .
3. Connect the radio ISO connectors to the ACI harness and then the Quadlock connector to the car's original connector.
4. Turn on the ignition and check to see that all functions are operating.

Note. To reset the ACI unit (to plug in a different adapter) remove the power supply three times.

For Becker radios move the microswitch between the two connectors towards the smaller 12 pin connector. The normal correct position for all other radio's is towards the larger 16 pin connector.

CHOOSE THE CORRECT HEAD-UNIT ADAPTER FROM THOSE BELOW

29-001 Alpine

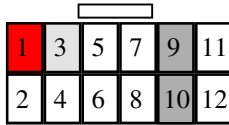

29-002 Blaupunkt

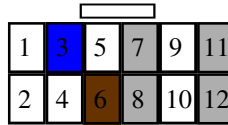

29-003 Clarion

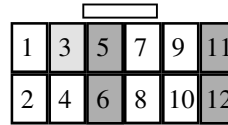

29-004 JVC

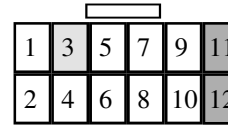

29-005 Kenwood
Single wire

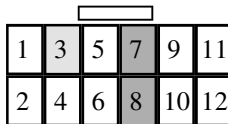

29-005D Kenwood
4 pin DIN Plug

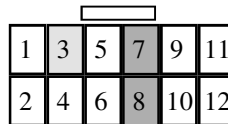

29-006 Panasonic
Standard CD units

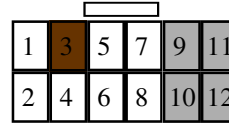

29-006A Panasonic
AV head-units

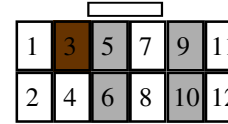

29-007 Pioneer
Units <2007

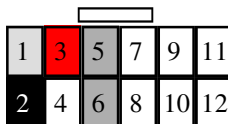

29-008 Sony &
Pioneer Units >2007

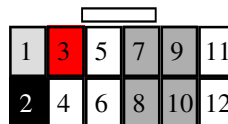

29-009 Siemens
VDO

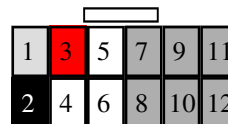

29-015 Becker

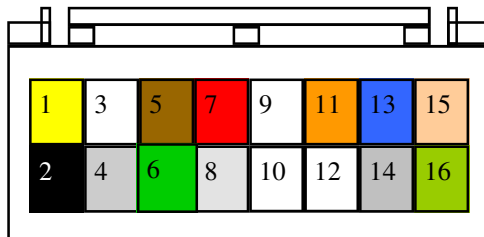
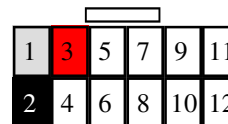

29-802

ACI Connector-Wire entry side

- | | |
|---------------------|-------------------------|
| 1- Yellow Power | 9- NC |
| 2- Black Ground | 10-NC |
| 3- NC | 11- Orange Illumination |
| 4- Grey Speed pulse | 12-NC |
| 5- Brown Reverse | 13-Blue Dongle PWR |
| 6- Green CAN High | 14-Grey Dongle CLK |
| 7- Red IGN out | 15-Pink Dongle Data |
| 8- White CAN Low | 16-Green Dongle GRND |

MERCEDES AUDIO20 Connector- Wire Entry Side

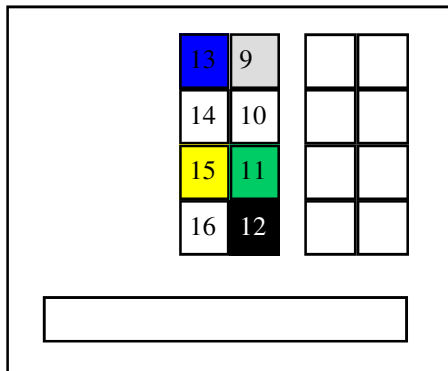

- 9-White CAN low
- 10-NC
- 11-Green CAN high
- 12-Black Ground
- 13-Blue 12v Antenna
- 14-NC
- 15-Yellow Memory
- 16- NC