

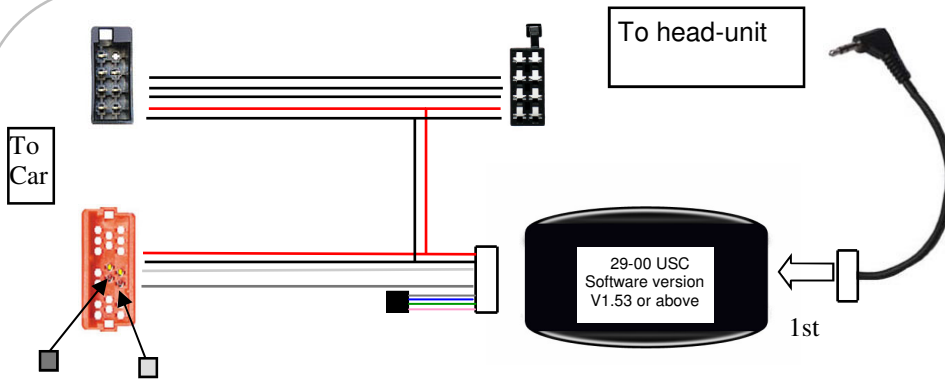

E-Mail: sales@incartec.co.uk
 Website: www.incartec.co.uk

Steering Control Adapter 29-616
 Citroen Evasion/Synergie (96-99)
 Peugeot 806(96-00) Fiat Ulysse(96-99)



1-ALWAYS CONNECT THE HEAD-UNIT CABLE ADAPTER 1st before ignition is turned on!

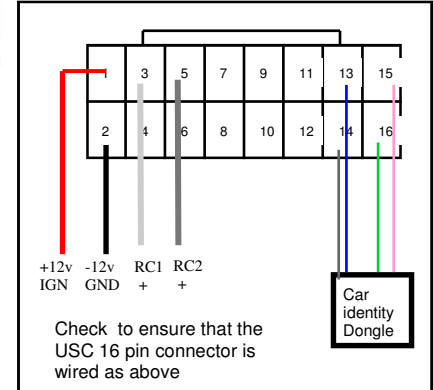

1. Choose a head-unit adapter from the list overleaf and connect it to the USC black box.
2. Turn off the ignition supply to the car!
3. Remove the OEM head-unit and identify the audio connector and ensure it mates correctly with the connector supplied with the 29 series cable.
4. Connect the 29 series cable to the car and to the ISO connectors on the new radio.
5. Check that the red wire is a 12V IGNITION source in the car then turn on ignition
6. Test unit before fully fitting radio and trims back.

If Problems: Check that correct adapter has been used and links are in the correct place. Always disconnect from the power supply if you change the head-unit adapter lead. Check that Red wire is 12V ignition and not Permanent power. Check that head-unit is earthed and black wire is earth. Check all connections are the same as the wiring diagram shown here



E-Mail: sales@incartec.co.uk
 Website: www.incartec.co.uk

Steering Control Adapter 29-616
 Citroen Evasion/Synergie (96-99)
 Peugeot 806(96-00) Fiat Ulysse(96-99)

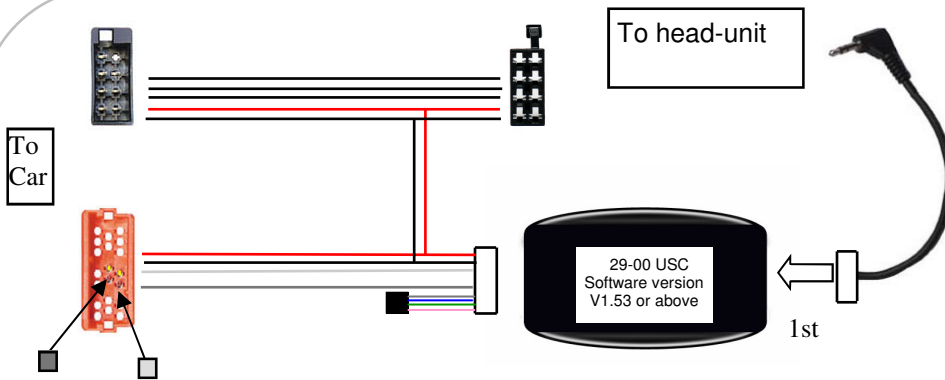

1-ALWAYS CONNECT THE HEAD-UNIT CABLE ADAPTER 1st before ignition is turned on!

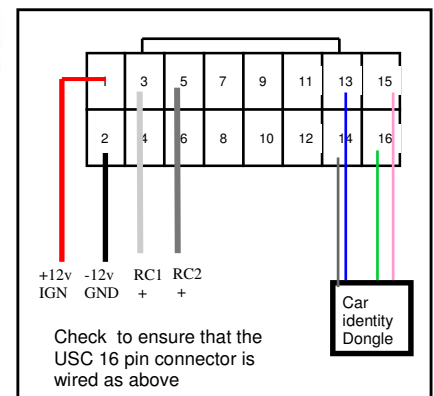

1. Choose a head-unit adapter from the list overleaf and connect it to the USC black box.
2. Turn off the ignition supply to the car!
3. Remove the OEM head-unit and identify the audio connector and ensure it mates correctly with the connector supplied with the 29 series cable.
4. Connect the 29 series cable to the car and to the ISO connectors on the new radio.
5. Check that the red wire is a 12V IGNITION source in the car then turn on ignition
6. Test unit before fully fitting radio and trims back.

If Problems: Check that correct adapter has been used and links are in the correct place. Always disconnect from the power supply if you change the head-unit adapter lead. Check that Red wire is 12V ignition and not Permanent power. Check that head-unit is earthed and black wire is earth. Check all connections are the same as the wiring diagram shown here

CHOOSE THE CORRECT HEAD-UNIT ADAPTER FROM THOSE BELOW

29-001 Alpine

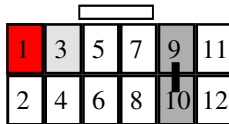

29-002 Blaupunkt

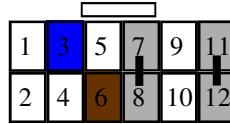

29-003 Clarion

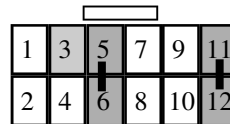

29-004 JVC

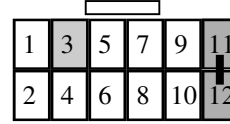

29-005 Kenwood
Single wire

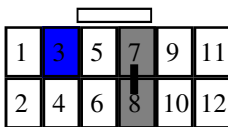

29-005D Kenwood
4 pin DIN Plug

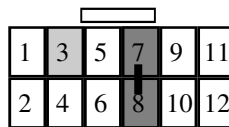

29-006 Panasonic
Standard CD units

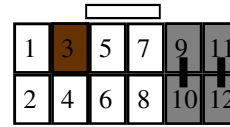

29-006A Panasonic
AV head-units

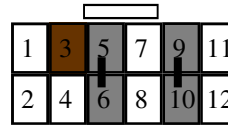

29-009 Siemens
VDO

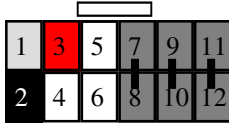

29-008 Sony
3v & 5v units

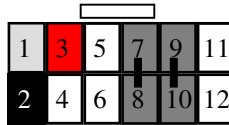

29-011 Zenec

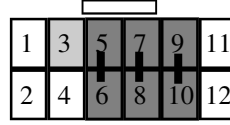

29-020 Pioneer &
Sony

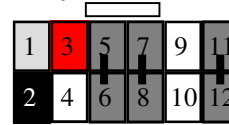

Special external drive
PCB version

CHOOSE THE CORRECT HEAD-UNIT ADAPTER FROM THOSE BELOW

29-001 Alpine

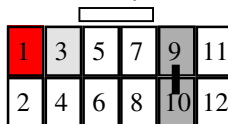

29-002 Blaupunkt

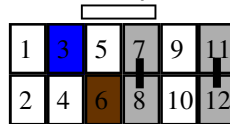

29-003 Clarion

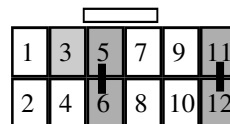

29-004 JVC

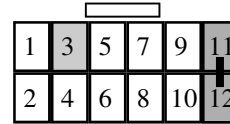

29-005 Kenwood
Single wire

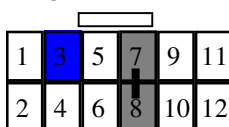

29-005D Kenwood
4 pin DIN Plug

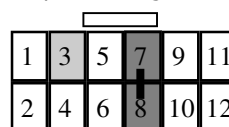

29-006 Panasonic
Standard CD units

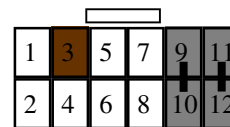

29-006A Panasonic
AV head-units

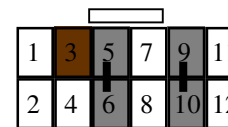

29-009 Siemens
VDO

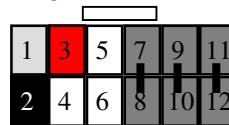

29-008 Sony
3v & 5v units



29-011 Zenec

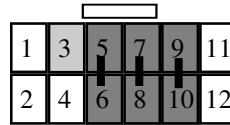

29-020 Pioneer &
Sony

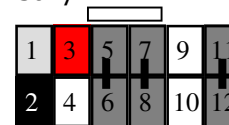

Special external drive
PCB version